



NQ723BD

User Manual



DIGITAL MEDIA RECEIVER

CONTENTS

Warnings&Precautions	1	EN
Product Features	2	EN
Accessory List	3	EN
Dimension(Unit:mm)	3	EN
Wiring Diagram	4	EN
Basic Functions Of Panel Keys	5	EN
Remote Operation	6	EN
Basic Operation	6	EN
Radio Operation	7	EN
Start Listening	7	EN
Tuner Settings	7	EN
Tunner Settings List	7	EN
Stereo/Mono Select	7	EN
DX/Local Select	7	EN
Tuner Area Select	7	EN
RDS ON/OFF	7	EN
USB&SD Playback	8	EN
Supported Audio Playback List	8	EN
Supported Devices	8	EN
Bluetooth Operation	9	EN
Bluetooth Pairing	9	EN
Bluetooth Basic Operation	9	EN
Bluetooth Music Operation	9	EN
AUX Input	10	EN
External Microphone	10	EN
Audio Settings	11	EN
Audio Settings List	11	EN
Subwoofer Volume Adjustment	11	EN
Preset EQ Select	11	EN
User EQ Setup	11	EN
X-BASS Adjustment	11	EN
Audio Settings	12	EN
3D Surround Setup	12	EN
DRC Gain adjustment	12	EN
DRC Slope Select	12	EN
Loudness Setup	12	EN
Bass Adjustment	12	EN
Treble Adjustment	12	EN
Balance Adjustment	12	EN
Fader Adjustment	12	EN
Audio Setup Reset	12	EN
Subwoofer Xover Setup	13	EN
Subwoofer Xover List	13	EN
Subwoofer Frequency Setup	13	EN
Subwoofer Phase Setup	13	EN
Subwoofer Gain Setup	13	EN
Subwoofer Slope Setup	13	EN
DTA Settings	14	EN
DTA Settings List	14	EN
Car Type Settings	14	EN
Listening Position Settings	14	EN
Delay Unit Settings	14	EN
DSP Reset	14	EN
Time Alignment(Distance)	15	EN
Clock And Date Settings	16	EN
Clock And Date Settings List	16	EN
Clock Format Settings	16	EN
Clock Adjust	16	EN
Date Format Settings	16	EN
Date Settings	16	EN
Display Settings	16	EN
Display Settings List	16	EN
Display Settings	17	EN
Key Light Select	17	EN
Spectrum On/Off	17	EN
ID3 On/Off	17	EN
System Version	17	EN
Animation Settings	17	EN
Demo Mode Select	17	EN
APP Operation	18	EN
APP Download	18	EN
APP Connection	18	EN
APP Operation	19	EN
Trouble Shooting	20	EN
Speaker Connection	20	EN
Specification	21	EN

WARNINGS & PRECAUTIONS

To avoid risk of serious injury or possible violation of laws, please read the following thoroughly before installation or connecting.



- This product is designed specifically for use with 12 volt, negative ground electrical systems only.
- Having the wiring and installation done by expert.
Be sure to disconnect the cable from the negative battery terminal while installation.
- This apparatus shall not be exposed to dripping or splashing, and no object filled with liquids, shall be placed on the apparatus.
- Fuses shall be replaced only with the correct type and fuse value, and only when the apparatus is powered off.
- To prevent a short circuit, never put or leave any metallic objects (such as coins or metallic tools) inside the unit.
- Never set the volume of this product so high that you cannot hear outside traffic and emergency vehicles.

PRODUCT FEATURES

Panel	Detachable
LCD	2-Line VA-LCD
Key Light	Multi Color
Bluetooth	Version 5.0
Bluetooth Music	Support
DSP	Built-in
EQ	40 band,8 Preset
Pre-Output	6CH x 4V
Max Power	4 x 50W
Digital Output	Optical
DRC	Support
Xbass	Support
Xover	Support
3D Surround	Support
Time alignment	0-20 ms
Q Value	1-20
Subwoofer Control	Support
Playback Interface	TF&USB
Phase	0° -180°
Listening bit setting	Support
Slope	0dB-24dB
PAC™-SWI	Support
Remote	Support
Microphone	Built-in and External
Radio	Preset 18FM,12AM, RDS
APP Control	iOS and Android Phone
Charge	Front USB 1A, Rear USB 2A
Audio Format	MP3,WMA,AAC,FLAC,APE

ACCESSORY LIST

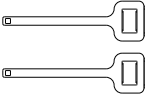
Please check the following accessories after opening the package:

<p>16P cable x1</p> 	<p>Remote x1</p> 	<p>Frame x1</p>  <p>Install on the host</p>
<p>Half sleeve x1</p>  <p>Install on the host</p>	<p>Diassemble keys x2</p> 	<p>User Manual x1</p> 

DIMENSION(UNIT:MM)

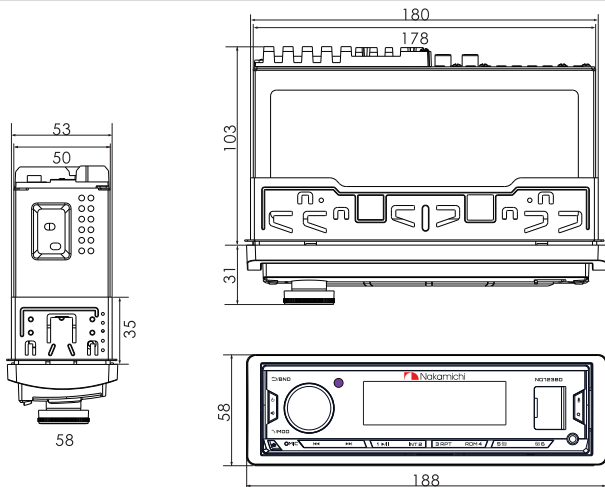

WIRING DIAGRAM

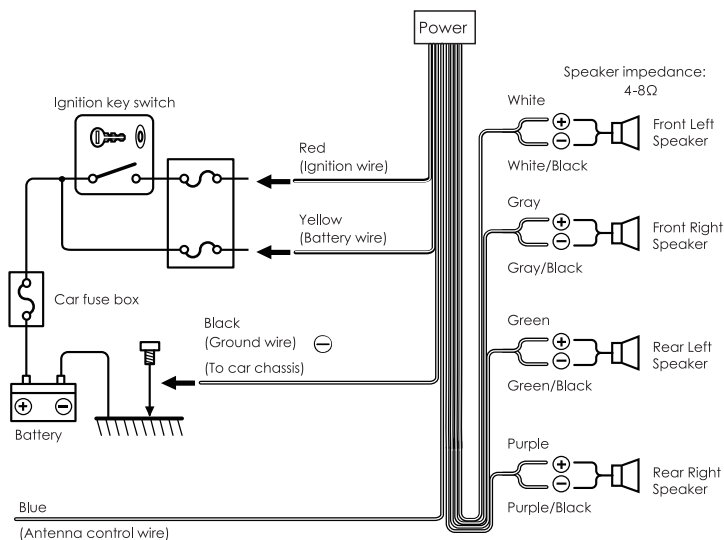
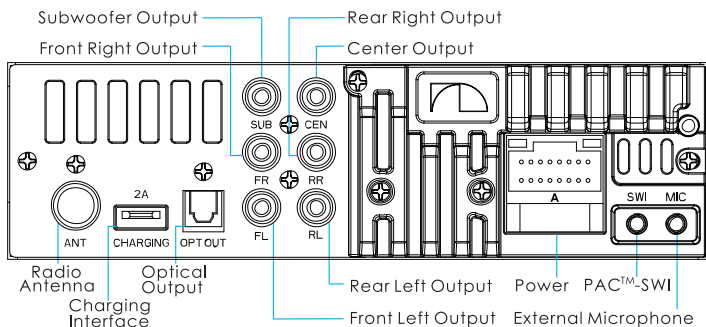

BASIC FUNCTIONS OF PANEL KEYS

To	Radio status	USB/TF/BT MUSIC Status
⏮ ⏭	Seek a station manually	Previous/Next track
1 ⏸	Preset 1	Playback/Pause
INT 2	Preset 2	Intro Playback
3 RPT	Preset 3	Repeat Playback
RDM 4	Preset 4	Random Playback
5 6	Preset 5/Preset 6	Previous/Next folder
↶/BND	Band select	
⏻ 🔊	Press to mute, Press and hold to power off	
🎤 🔍	Press to turn on voice, Press an hold to auto memory	
↶/MOD	Press to select a source/Answer call Press an hold to last call	

Return(When menu) Volume control/Menu Remote control receiver

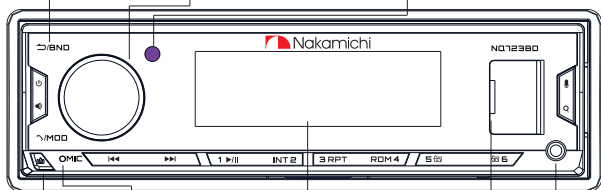

Detach button Microphone Display windows USB port AUX input

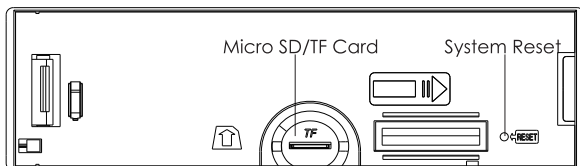

Attach



Detach

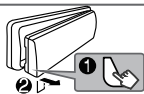

REMOTE OPERATION



Basic Operation

To	Operation (panel)
Power on	Press any button
Power off	Press and hold /
Mute	Press /
Volume up and down	Turn the knob
Source select	Press /MOD
Menu	Press the knob
Return	Press /BND (In menu status)
Turn on voice	Press (Bluetooth is connected)

RADIO OPERATION

Start Listening

To	Operation (panel)	Remark
Auto memory	Press and hold Q	18 FM/12AM
Band selection	Press \rightarrow /BND	FM1/FM2/FM3/AM1/AM2
Seek a station manually	Press \lll \ggg	
Search the next or previous frequency step by step	Press and hold \lll \ggg	
Store a station	Press and hold 1-6	

TUNER SETTINGS

- 1.Press the knob to enter the [MENU].
- 2.Turn the knob to select [TUNER],then press the knob.

Tuner Settings List

Menu	Adjustment	
TUNER	STEREO/MONO	NEWS/AFFAIRS/INFO/SPORT
	DX/LOC	EDUCATE/DRAMA/CULTURE
	REGIONAL EUROPE/USA/ASIA/RUSSIA	SCIENCE/VARIED/ROCK M
	RDS OFF/ON	EASY M/LIGHT M/CLASSICS
	TA OFF/ON	OTHER M/WEATHER/FINANCE
	AF ON/OFF	CHILDREN/SOCIAL/RELIGION
	EON OFF/ON	PHONE IN/TRAVEL/LEISURE
PI REG OFF/ON	JAZZ/COUNTRY/NATION M	
PTY OFF/ON	OLDIES/FOLK M/DOCUMENT	

Stereo/Mono Select

Turn the knob to select [STEREO or MONO],then turn the knob select [STEREO/MONO].

DX/Local Select

Turn the knob to select [LOC or DX],then turn the knob select [DX /LOCAL].

Remark: DX:Distant exchange

Tuner Area Select

Turn the knob to select [REGIONAL],then turn the knob select [ASIA/OIRT/EUR/USA].

RDS ON/OFF

Turn the knob to select [RDS OFF],then turn the knob select [RDS OFF,ON].

USB&SD PLAYBACK

To	Operation (panel)
Track selection	Press ⏮ ⏭
Fast playback	Press and hold ⏮ ⏭
Playback/Pause	Press 1/▶
Track pre-play	Press INT 2
Repeat playback	Press 3 RPT • REPEAT ONE.REPEAT DIR.REPEAT ALL
Random playback	Press RDM 4 • ON/OFF
Folder selection	Press 5 [Folder Icon] 6

SUPPORTED AUDIO PLAYBACK LIST

Audio	Stream	Sampling Rate	Remark
MP3	32kbps-384kbps	8/11.025/12/16/22.05 24/32/44.1/48KHz	MPEG1/2/2.5 Layer II&III
WMA	0kbps-320kbps	8/11.025/12/16/22.05 24/32/44.1/48KHz	WMA standard 4/4/1/7/8/9.1
APE	all bitrates allowed	8/16/22.05/24/32 44.1/48KHz	PCM Bit width 8/12/16/24bits
FLAC	all bitrates allowed	8/16/22.05/24/32 44.1/48/96KHz	PCM Bit width 8/12/16/24bits
AAC	all bitrates allowed	8/11.025/12/16/22.05 24/32/44.1/48KHz	MPEG2/4 AAC LC profile
M4A	all bitrates allowed	8/11.025/12/16/22.05 24/32/44.1/48KHz	ISO/IEC 14496-3 Amd 1:2003
WAV	32kbps-384kbps	8/11.025/12/16/22.05 24/32/44.1/48KHz	4 bit ADPCM only

SUPPORTED DEVICES

Device	Maximum capacity	Device format
USB	256GB	FAT16/FAT32/exFAT
Micro SD/TF	256GB	FAT16/FAT32/exFAT

BLUETOOTH OPERATION

Bluetooth Pairing

The first time pair mobile phone with receiver, please follow below steps:

1. When there is no pairing, in any mode, the BT1 on the LCD will flash, and the pairing can be performed at this time.
2. Turn on the phone's Bluetooth to Search NQ723BD.
3. Click on the NQ723BD on the phone to connect. After the connection is successful, the BT1 will stop flashing.
4. When pairing is complete, the mobile phone audio will automatically transfer to the car audio system whenever a call is made or received, or when the mobile phone plays music.

Note:

For more details of bluetooth pairing, please refer to the owner's manual for your mobile phone.

Bluetooth Basic Operation

To	Operation (panel)
Make a call	Bluetooth mobile phone connected
Answer a call	Press ↵/MOD
Reject an incoming call	Press an hold ↵/MOD
Switch between the current caller and a caller on hold	Press ↵/MOD (In a call)
End a call	Press an hold ↵/MOD (In a call)
Adjust call volume	Turn on the knob

Bluetooth Music Operation

To	Operation (panel)
Previous track	Press ⏮
Next track	Press ⏭
Playback/Pause	Press 1/⏩

AUX INPUT

1. Connect a portable audio player (commercially available).
Auxiliary input jack

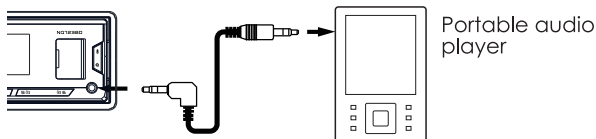

Auxiliary input jack

3.5mm stereo mini plug with "L" shaped connector.
(commercially available).

2. Press [\sim /MOD] buttons to select AUX IN.
3. Turn on the portable audio player and start playback.

EXTERNAL MICROPHONE

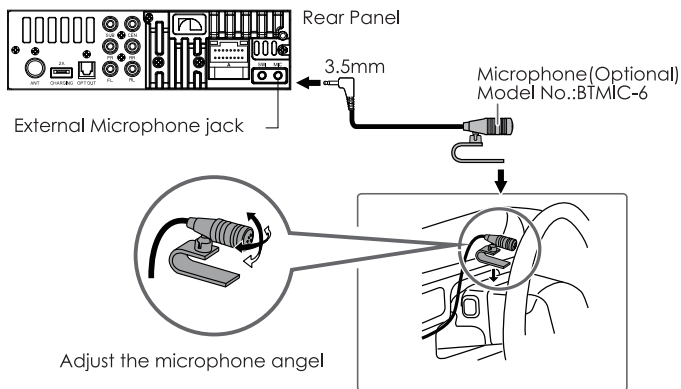

Note:

Since the panel microphone is far from the driver's position, when using an external microphone, you can get better voice calls.

AUDIO SETTINGS

- 1.Press the knob to enter the [MENU].
- 2.Turn the knob to select [AUDIO],then press the knob.

Audio Settings List

Menu	Adjustment
SW LEVEL	SVOL -8 ~ +8
PRESET EQ	USER/NATURAL/POP/CLASSIC/ROCK/JAZZ/FLAT/SUPER BASS └ 30Hz/60Hz/80Hz/100Hz/120Hz/160Hz/250Hz/400Hz 600Hz/ 800Hz/1KHz/1.5KHz/2KHz/2.5KHz/3KHz/3.5K/4K 4.5K/5K/5.5K/ 6K/6.5K/7K/7.5K/8K/8.5K/9K/9.5K/10K/11K /12K/13K/14K/15K/ 15.5K/16K/17K/18K/19K/20K
XBASS	FREQ OFF/60Hz/80Hz/120Hz/160Hz/200Hz/300Hz
	GAIN 0~10
3D SURROUND	OFF/ON
DRC	GAIN 0~5
	SLOPE 0/6dB/12dB/18dB/24dB
LOUD	OFF/ON
BASS	BASS -7 ~ +7
TREBLE	TREBLE -7 ~ +7
BALANCE	BALANCE L7-L0,0,R1-R7
FADER	FADER R7-R0,0,F1-F7
AUDIO RESET	NO/YES

Subwoofer Volume Adjustment

- 1.Turn the knob to select [SW LEVEL],then press the knob.
- 2.Turn the knob to adjustment SVOL [-8 to +8].

Preset EQ Select

- 1.Turn the knob to select [PRESET EQ],then press the knob.
- 2.Turn the knob to select [USER/NATURAL/POP/CLASSIC/ROCK/
JAZZ/FLAT/SUPER BASS].

User EQ Setup

- 1.Turn the knob to select [PRESET EQ],then press the knob.
- 2.Turn the knob to select [USER],then press the knob.
- 3.Turn the knob to select frequency for adjustment.

X-BASS Adjustment

- 1.Turn the knob to select [XBASS],then press the knob.
- 2.Turn the knob to adjustment [0-10].

AUDIO SETTINGS

- 1.Press the knob to enter the [MENU].
- 2.Turn the knob to select [AUDIO],then press the knob.

3D Surround Setup

- 1.Turn the knob to select [3D SURROUND],then press the knob.
- 2.Turn the knob to select [OFF/ON].

DRC Gain adjustment

- 1.Turn the knob to select [DRC],then press the knob.
- 2.Turn the knob to select [GAIN],then press the knob.
- 3.Turn the knob to adjustment[0-5].

Remark:

DRC: Dynamic range compression.

Can make small signals louder and stronger, and make high-amplitude signals undistorted.

DRC Slope Select

- 1.Turn the knob to select [DRC],then press the knob.
- 2.Turn the knob to select [SLOP],then press the knob.
- 3.Turn the knob to select [0DB/6DB/12DB/24DB].

Loudness Setup

- 1.Turn the knob to select [LOUND],then press the knob.
- 2.Turn the knob to select [OFF/ON].

Bass Adjustment

- 1.Turn the knob to select [BASS],then press the knob.
- 2.Turn the knob to adjustment [-7 to +7].

Treble Adjustment

- 1.Turn the knob to select [TREBLE],then press the knob.
- 2.Turn the knob to select [-7 to +7].

Balance Adjustment

- 1.Turn the knob to select [BALANCE],then press the knob.
- 2.Turn the knob to select [L7-L0 toR1-R7].

Fader Adjustment

- 1.Turn the knob to select [FADER],then press the knob.
- 2.Turn the knob to select [R7-R0 toF1-F7].

Audio Setup Reset

- 1.Turn the knob to select [AUDIO RESET],then press the knob.
- 2.Turn the knob to select [NO/YES].

SUBWOOFER XOVER SETUP

- 1.Press the knob to enter the [MENU].
- 2.Turn the knob to select [X/OVER],then press the knob.
- 3.Turn the knob to select [SUB SET],then press the knob.

Subwoofer Xover List

Menu	Adjustment	
SUB SET	SW LPF FREQ	OFF/30Hz/60Hz/80Hz/100Hz/120Hz, 150Hz/180Hz/200Hz/250Hz/300Hz
	SW LPF PHASE	NORMAL/REVERSE
	SW LPF GAIN	0-5
	SW LPF SLOPE	0dB/6dB/12dB/18dB/24dB

Subwoofer Frequency Setup

- 1.Turn the knob to select [SW LPF FREQ],then press the knob.
- 2.Turn the knob to select frequency[OFF/30Hz/60Hz/80Hz/100Hz/120Hz
150HZ/180HZ/200H/250HZ/300HZ].

Subwoofer Phase Setup

- 1.Turn the knob to select [SW LPF PHASE],then press the knob.
- 2.Turn the knob to select [NORMAL/REVERSE].

Subwoofer Gain Setup

- 1.Turn the knob to select [SW LPF GAIN],then press the knob.
- 2.Turn the knob to select [0-5].

Subwoofer Slope Setup

- 1.Turn the knob to select [SW LPF SLOPE],then press the knob.
- 2.Turn the knob to select [0dB/6dB/12dB/18dB/24dB].

DTA SETTINGS

- 1.Press the knob to enter the [MENU].
- 2.Turn the knob to select [DTA SET],then press the knob.

DTA Settings List

Menu	Adjustment	
CAR TYPE	SMALL CAR/MEDIUM CAR/LARGE CAR	
POSITION	USER/FRONT R/FRONT L/CENTER	
DELAY UNIT	CM/MS/INCH	
DISTANCE	FRONT LEFT	FL 0-680CM
	FRONT RIGHT	FR 0-680CM
	REAR LEFT	RL 0-680CM
	REAR RIGHT	RR 0-680CM
	SUBWOOFER	SUB 0-680CM
DTA RST	NO/YES	

Car Type Settings

- 1.Turn the knob to select [CAR TYPE],then press the knob.
- 2.Turn the knob to select [SMALL CAR/MEDIUM CAR/LARGE CAR].

Listening Position Settings

- 1.Turn the knob to select [POSITION],then press the knob.
- 2.Turn the knob to select [USER/FRONT R/FRONT L/CENTER].

Delay Unit Settings

- 1.Turn the knob to select [DELAY UNIT],then press the knob.
- 2.Turn the knob to select [CM/MS/INCH].

DSP Reset

- 1.Turn the knob to select [DTA RST],then press the knob.
- 2.Turn the knob to select [NO/YES].

TIME ALIGNMENT(DISTANCE)

- 1.Press the knob to enter the [MENU].
- 2.Turn the knob to select [DTA SET],then press the knob.
- 3.Turn the knob to select [DISTANCE],then press the knob.
- 4.Turn the knob to select[FRONT LEFT/FRONT RIGHT/REAR LEFT/REAR RIGHT/SUBWOOFER] to adjustment.

Determining the value for<Position> adjustment.

- ① Determine the center of the currently set listening position as the reference point.
- ② The adjustable speaker has five directions: front left, front right, back left, back right, and back.
- ③ The time for the speakers in the five directions to reach the center is the same by default.
- ④ Set the value for each speaker, the delay range: 0-20ms
- ⑤ Adjust the increase or decrease of each speaker, 0.2ms each time.

Example: When <back> is selected as the listening position

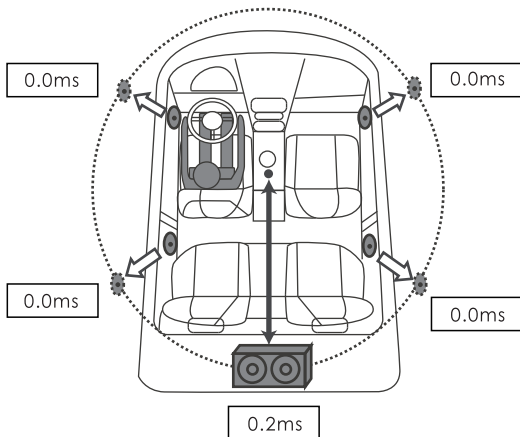

CLOCK AND DATE SETTINGS

- 1.Press the knob to enter the [MENU].
- 2.Turn the knob to select [CLOCK],then press the knob.

Clock And Date Settings List

Menu	Adjustment
CLOCK FORMAT	12H/24H
CLOCK ADJUST	00:00
DATE FORMAT	DD-MM-YY/MM-DD-YY
DATE SET	17/07/2021

Clock Format Settings

- 1.Turn the knob to select [CLOCK FORMAT],then press the knob.
- 2.Turn the knob to select [12H/24H].

Clock Adjust

- 1.Turn the knob to select [CLOCK ADJUST],then press the knob.
- 2.Turn the knob to adjustment.
- 3.Press the knob to switch the clock/minute adjustment.

Date Format Settings

- 1.Turn the knob to select [DATE FORMAT],then press the knob.
- 2.Turn the knob to select [DD-MM-YY/MM-DD-YY].

Date Settings

- 1.Turn the knob to select [DATE SET],then press the knob.
- 2.Turn the knob to adjustment.
- 3.Press the knob to switch day/month/year adjustment.

DISPLAY SETTINGS

Display Settings List

Menu	Adjustment
COLOR SELECT	AUTO/RED/GREEN/BLUE/YELLOW/ CYAN/PURR/WHITE
SPECTRUM	OFF/ON
ID3 TAG	OFF/ON
VERSION	VER 2.0 DSP

DISPLAY SETTINGS

- 1.Press the knob to enter the [MENU].
- 2.Turn the knob to select [DISPLAY],then press the knob.

Key Light Select

- 1.Turn the knob to select [COLOR SELECT],then press the knob.
- 2.Turn the knob to select key light color:AUTO/RED/GREEN /BLUE/YELLOW/CYAN/PURPLE/WHITE(Knob Select).

Spectrum ON/OFF

- 1.Turn the knob to select [SPECTRUM],then press the knob.
- 2.Turn the knob to select [OFF/ON].

ID3 ON/OFF

- 1.Turn the knob to select [ID3],then press the knob.
- 2.Turn the knob to select [OFF/ON].

System Version

Turn the knob to select [VERSION],then press the button to query the system version information.

ANIMATION SETTINGS

- 1.Press the knob to enter the [MENU].
- 2.Turn the knob to select [ANIMATION],then press the knob.
- 3.Turn the knob to select [OFF/PER 15SEC/30SEC/1MIN/2MINS/4MINS].

Menu	Adjustment
ANIMATION	OFF/PER 15SEC/30SEC/1MIN/2MINS/4MINS

DEMO MODE SELECT

- 1.Press the knob to enter the [MENU].
- 2.Turn the knob to select [DEMO MODE],then press the knob.
- 3.Turn the knob to select [OFF/ON].

Menu	Adjustment
DEMO MODE	OFF/ON

APP OPERATION

APP Download

Please go to the APPALE APP Store or Google Play Store and search [Nakamichi AMC] app, after downloading the APP, install it on your Appale&Android devices.

APP Connection

1. Open the [Nakamichi AMC] APP, click [🔍] to search for NQ723BD.
2. Click NQ723BD to connect, the [🔴] will be red after the connect is successful.

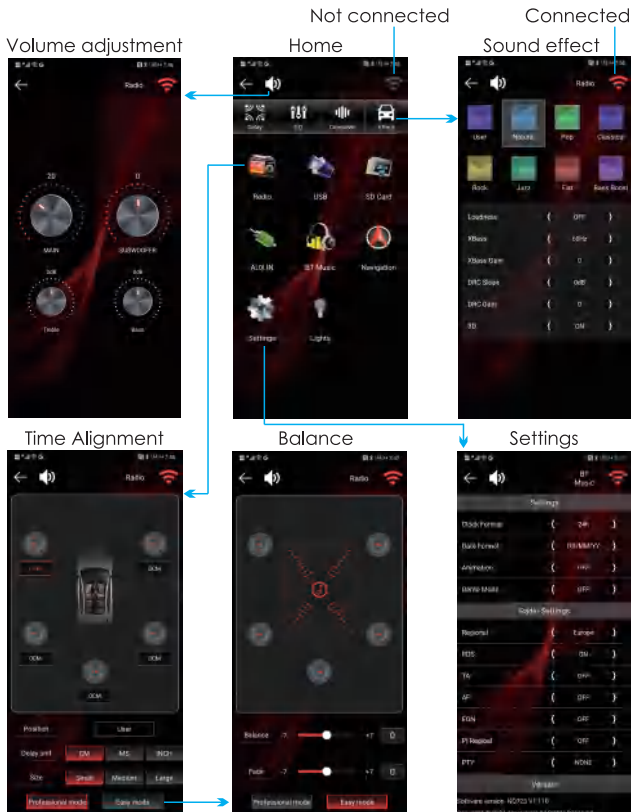

APP OPERATION

EQ Settings

Frequency

Gain

Q value

Select up and down

Adjustment

Band	1	2	3	4	5	6	7	8	9	10
Frequency	20 Hz	34.6 Hz	56.2 Hz	90.7 Hz	144.7 Hz	233.1 Hz	375 Hz	598.4 Hz	953.3 Hz	1500 Hz
Gain	0 dB	0 dB	0 dB	0 dB	0 dB	0 dB	0 dB	0 dB	0 dB	0 dB
Q	1.0	1.41	1.73	2.0	2.24	2.5	2.83	3.16	3.55	4.0

Radio

Home

Crossover

Bluetooth Music Playback

Key Lights

USB/SD Playback

TROUBLE SHOOTING

Not work

Fuse blown
Loose panel contact

Remedy

Replace the fuse: small 10A(Red)
Take out the panel and reinstall

Not responding

System problem

Reset the unit

No bass

Subwoofer setting level
is too small

Enter AUDIO to set SVOL

Can't turn on voice

Bluetooth is not connected
Phone does not support voice

Connect Bluetooth
N.A

Not playing

Incorrect device format
Device error
Unsupported audio file

Reformat
Replacement device
Replace supported audio files

Radio reception is poor

Poor contact of radio antenna
Poor signal at location

Reconnect the radio antenna
Change to other positions

Remote control is invalid

Remote control battery is low

Replace CR2025 battery

Bluetooth call is poor

Microphone is too far away

Speak into the microphone

SPEAKER CONNECTION

Do not connect the speaker leads of the power cord to the car battery; otherwise, the unit will be seriously damaged.

Before connecting the speaker leads of the power cord to the speakers, check the speaker wiring in your car.

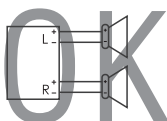
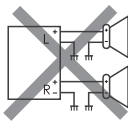
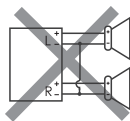

SPECIFICATION

GENERAL	Operating Voltage	14.4V(10.8V allowable)
	Maximum Current	10A
	Operational Temperature	-10°~+60°
	Installation Size(WxHxD)	182mmx53mmx115mm
	Net Weight	0.5kg
	Fuse	Small fuse 10A(Red)
AUDIO	Maximum Output Power	50Wx4
	Speaker Impedance	4-8ohm
	Pre-output Level	4V
RADIO	FM Frequency Range	87.5MHz-108.0MHz
	AM Frequency Range	522KHz-1710KHz
	Preset	18 FM,12 AM
USB	USB Standard	USB1.1,USB2.0 Full Speed
	Audio Format	MP3/WMA/APE/FLAC/ AAC/M4A/WAV
	Front USB	Read/charge DC 5V \pm 1A
	Rear USB	Charge DC 5V \pm 2A
BLUETOOTH	Version	Bluetooth 5.0
	Frequency Range	2.402GHz-2.480GHz
	Communication Range	Line of sight approx.10m
	Profile	HPF1.6/A2DP/AVR/SPP



CONNECT WITH US ONLINE TO EXPLORE NAKAMICHI'S COMPLETE RANGE,
INSTRUCTIONS & SOFTWARE DOWNLOADS AND WARRANTY REGISTRATION.

WWW.NAKAMICHICARAUDIO.COM

 [nakamichi.global](https://www.facebook.com/nakamichi.global)  [nakamichi.caraudio](https://www.instagram.com/nakamichi.caraudio)

Made in China | 中國製造